

Avanti® J-E Centrifuge

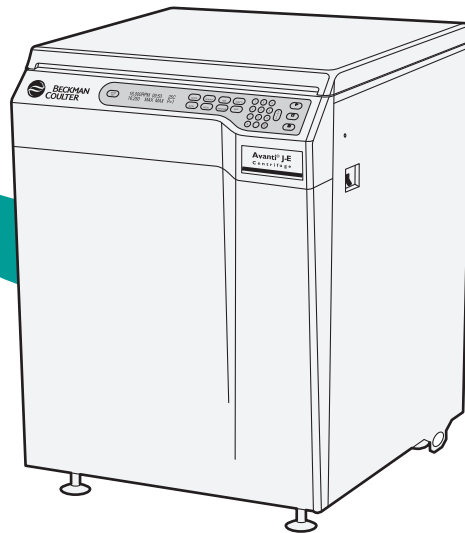

Instruction Manual

Symbol Symbol Symbole Símbolo	Simbolo 記号 符号 Title / Titel / Titre / Titolo / Titolo / 名称 / 名称
	Dangerous voltage Gefährliche elektrische Spannung Courant haute tension Voltaje peligroso Pericolo: alta tensione 危険電圧 危险电压
	Attention, consult accompanying documents Achtung! Begleitpapiere beachten! Attention, consulter les documents joints Atención, consulte los documentos adjuntos Attenzione: consultare le informazioni allegate 注意、添付資料を参照のこと 注意，请参阅附带的文件
	On (power) Ein (Netzverbindung) Marche (mise sous tension) Encendido Acceso (sotto tensione) 入（電源） 开（电源）
	Off (power) Aus (Netzverbindung) Arrêt (mise hors tension) Apagado Spento (fuori tensione) 切（電源） 关（电源）
	Protective earth (ground) Schutzleiteranschluß Liaison à la terre Puesta a tierra de protección Collegamento di protezione a terra 保護アース（接地） 保护接地
	Earth (ground) Erde Terre Tierra Scarica a terra アース（接地） 接地



SAFETY NOTICE

This safety notice summarizes information basic to the safe operation of the equipment described in this manual. The international symbol displayed above is a reminder that all safety instructions should be read and understood before installation, operation, maintenance, or repair of this centrifuge. When you see the symbol on other pages, pay special attention to the safety information presented. Observance of safety precautions will also help to avoid actions that could damage or adversely affect the performance of the centrifuge.

Safety During Installation and/or Maintenance

This centrifuge is designed to be installed by a Beckman Coulter Field Service representative. Installation by anyone other than authorized Beckman Coulter personnel invalidates any warranty covering the instrument.

Any servicing of this equipment that requires removal of any covers can expose parts which involve the risk of electric shock or personal injury. Make sure that the power switch is off and the centrifuge is disconnected from the main power source, and refer such servicing to qualified personnel.

Use the anchoring system to secure the centrifuge in place. The anchoring system is designed to reduce the possibility of injury or damage that could result from instrument movement in the event of a major rotor mishap.

Do not replace any centrifuge components with parts not specified for use on this instrument.

Electrical Safety

To reduce the risk of electrical shock, this equipment uses a three-wire electrical cord and plug to connect the centrifuge to earth-ground. To preserve this safety feature:

- Make sure that the matching wall outlet receptacle is properly wired and earth-grounded. Check that the line voltage agrees with the voltage listed on the name-rating plate affixed to the centrifuge.
- Never use a three-to-two wire plug adapter.
- Never use a two-wire extension cord or a two-wire non-grounding type of multiple-outlet receptacle strip.

Do not place containers holding liquid on or near the chamber door. If they spill, liquid may get into the centrifuge and damage electrical or mechanical components.

Safety Against Risk of Fire

Fuses protect certain electrical circuits within this instrument against overcurrent conditions. For continued protection against the risk of fire, replace only with the same type and rating specified.

This centrifuge is not designed for use with materials capable of developing flammable or explosive vapors. Do not centrifuge such materials (such as chloroform or ethyl alcohol) in this centrifuge nor handle or store them within the required 30-cm (1-ft) area surrounding the centrifuge.

Mechanical Safety

For safe operation of the equipment, observe the following:

- Use only the rotors and accessories designed for use in this centrifuge.
- Do not exceed the maximum rated speed of the rotor in use.
- Do not lift or move the centrifuge while the rotor is spinning.
- NEVER attempt to slow or stop the rotor by hand.
- NEVER attempt to override the door interlock system while the rotor is spinning.
- In the event of a power failure, do not attempt to retrieve the sample from the centrifuge for at least 1 hour. Then follow the instructions for sample recovery in Section 4, TROUBLESHOOTING.

Chemical and Biological Safety

Normal operation may involve the use of solutions and test samples that are pathogenic, toxic, or radioactive. Such materials should not be used in this centrifuge, however, unless *all necessary safety precautions are taken*.

- Observe all cautionary information printed on the original solution containers prior to their use.
- Handle body fluids with care because they can transmit disease. No known test offers complete assurance that they are free of micro-organisms. Some of the most virulent—Hepatitis (B and C) and HIV (I–V) viruses, atypical mycobacteria, and certain systemic fungi—further emphasize the need for aerosol protection. Handle other infectious samples according to good laboratory procedures and methods to prevent spread of disease. Because spills may generate aerosols, observe proper safety precautions for aerosol containment. Do not run toxic, pathogenic, or radioactive materials in this centrifuge without taking appropriate safety precautions. Biosafe containment should be used when Risk Group II materials (as identified in the World Health Organization *Laboratory Biosafety Manual*) are handled; materials of a higher group require more than one level of protection.
- Dispose of all waste solutions according to appropriate environmental health and safety guidelines.

It is your responsibility to decontaminate the centrifuge and accessories before requesting service by Beckman Coulter field service.

Avanti® J-E Centrifuge

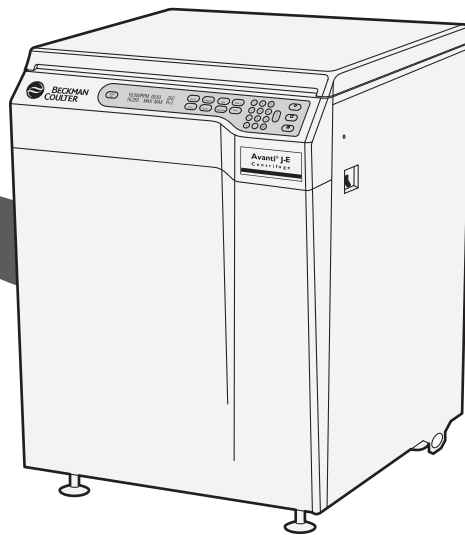

Instruction Manual

	Page
INTRODUCTION	
<i>Certification</i>	vii
<i>Scope of Manual</i>	vii
<i>Conventions</i>	viii
<i>Notes, Cautions, and Warnings</i>	viii
<i>Typographic Conventions</i>	ix
<i>CFC-Free Centrifugation</i>	ix
<i>Radio Interference</i>	x
<i>Canadian Regulations</i>	x
<i>Recycling Label</i>	x
SECTION 1: DESCRIPTION	
Description	1-1
Centrifuge Function	1-1
Housing and Door	1-2
Rotor Chamber	1-3
Vacuum	1-3
Temperature Control	1-3
Drive	1-4
Control and Indicators	1-4
Power Switch	1-4
Control Panel	1-4
Safety Features	1-8
Door	1-8
Protective Ring	1-8
Imbalance Detector	1-9
Overspeed and Rotor Identification System	1-9
Name Rating Plate	1-9
Specifications	1-10
Available Rotors	1-11
SECTION 2: PREINSTALLATION REQUIREMENTS	
Space Requirements	2-1
Electrical Requirements	2-3
Securing the Centrifuge to the Floor	2-4
Bio-Safety Level 3 Installation	2-5

SECTION 3: OPERATION

Summary of Run Procedures 3-2
 Programmed Run 3-2
 Manual Run 3-3
 Preparation 3-3
 Installing the Rotor 3-4
 Manual Operation 3-5
 Selecting a Rotor 3-5
 Entering Run Speed 3-6
 Entering Run Time 3-6
 Entering Run Temperature 3-7
 Entering Acceleration and Deceleration Rates 3-8
 Starting a Run 3-9
 Programmed Operation 3-9
 Creating a New Program 3-10
 Starting a Programmed Run 3-10
 Recalling and Changing a Program 3-11

SECTION 4: TROUBLESHOOTING

User Messages 4-1
 Retrieving Your Sample in Case of Power Failure 4-4

SECTION 5: MAINTENANCE

Instrument Care 5-1
 Maintenance 5-2
 Cleaning 5-2
 Decontamination 5-3
 Sterilization and Disinfection 5-3
 Replacing the Air Filter 5-4
 Circuit Breaker and Fuses 5-5
 Storage and Transportation 5-5
 Storage 5-5
 Supply List 5-6
 Replacement Parts 5-6
 Supplies 5-6

Warranty

Illustrations and Tables

	Page
Figure 1-1. The Avanti® J-E Centrifuge	1-1
Figure 1-2. Control Panel	1-4
Figure 2-1. Dimensions of the Avanti® J-E Centrifuge	2-2
Figure 2-2. Single-Phase Power Connection	2-3
Figure 4-1. Manual Door Release	4-6
Figure 5-1. Air Filter Replacement	5-4
Table 4-1. Diagnostic Message Chart	4-2

CERTIFICATION

To ensure full system quality, Beckman Coulter Avanti® J-E centrifuges have been manufactured in a registered ISO 9001 or 13485 facility. They have been designed and tested to be compliant (when used with Beckman Coulter rotors) with the laboratory equipment requirements of applicable regulatory agencies. Declarations of conformity and certificates of compliance are available at www.beckmancoulter.com.

SCOPE OF MANUAL

This manual is designed to familiarize you with the Avanti® J-E centrifuge, its functions, specifications, operation, and routine operator care and maintenance. We recommend that you read this entire manual, especially the SAFETY NOTICE and all safety-related information, before operating the centrifuge or performing instrument maintenance.

- Section 1 contains system specifications and a brief physical and functional description of the centrifuge, including the operating controls and indicators, and available rotors.
- Section 2 provides information about space and power requirements for installing and connecting the centrifuge.
- Section 3 contains centrifuge operating procedures.
- Section 4 lists possible malfunctions, together with probable causes and suggested corrective actions.
- Section 5 contains procedures for routine operator care and maintenance, as well as a brief list of supplies and replacement parts.

 **NOTE**

If the centrifuge is used in a manner other than specified in this manual, the safety and performance of this equipment could be impaired. Further, the use of any equipment other than that recommended by Beckman Coulter has not been evaluated for safety. Use of any equipment not specifically recommended in this manual and/or the applicable rotor manual is the sole responsibility of the user.

CONVENTIONS

Certain symbols are used in this manual to call out safety-related and other important information. These international symbols may also be displayed on the centrifuge and are reproduced and described below and on the inside of the front cover.

NOTES, CAUTIONS, AND WARNINGS

 **NOTE**

Used to call attention to important information that should be followed during installation, use, or servicing of this equipment.



CAUTION

Used to indicate a potentially hazardous situation which, if not avoided, may result in minor or moderate injury and/or mechanical damage. It is also used to alert against unsafe practices.



WARNING

Used whenever an action or condition may potentially cause personal injury or loss of life. Mechanical damage may also result.



WARNING

Indicates high voltage or risk of electric shock. Refer servicing of all areas displaying either symbol to service personnel.

TYPOGRAPHIC CONVENTIONS

Certain typographic conventions are used throughout this manual to distinguish names of user interface components, such as keys.

- *Keynames* (for example, [START] or [PROGRAM]) appear in capital letters within brackets.

CFC-FREE CENTRIFUGATION



To ensure minimal environmental impact, no CFCs are used in the manufacture or operation of Avanti J-E centrifuges.

RADIO INTERFERENCE

This equipment has been tested and found to comply with the limits for a Class A digital device, pursuant to Part 15 of FCC Rules. These limits are designed to provide reasonable protection against harmful interference when the equipment is operated in a commercial environment. This equipment generates, uses, and can radiate radio frequency energy and, if not installed and used in accordance with this instruction manual, may cause interference to radio communications. Operation of this equipment in a residential area is likely to cause interference, in which case the user will be required to correct the interference at his own expense.

CANADIAN REGULATIONS

This equipment does not exceed the Class A limits for radio noise emissions from digital apparatus as set out in the radio interference regulations of the Canadian Department of Communications.

Le présent appareil numérique n'émet pas de bruits radioélectriques dépassant les limites applicables aux appareils numériques de Classe A prescrites dans le règlement sur le brouillage radioélectrique édicté par le Ministère des Communications du Canada.

RECYCLING LABEL



Note: On the instrument, the triangle background is yellow rather than gray.

This symbol is required in accordance with the Waste Electrical and Electronic Equipment (WEEE) Directive of the European Union. The presence of this marking on the product indicates:

- 1) the device was put on the European market after August 13, 2005 and
- 2) the device is not to be disposed via the municipal waste collection system of any member state of the European Union.

It is very important that customers understand and follow all laws regarding the proper decontamination and safe disposal of electrical equipment. For Beckman Coulter products bearing this label please contact your dealer or local Beckman Coulter office for details on the take back program that will facilitate the proper collection, treatment, recovery, recycling and safe disposal of the device.

**DESCRIPTION****CENTRIFUGE FUNCTION**

The Avanti® J-E high-performance centrifuge (see Figure 1-1) is a refrigerated centrifuge that generates centrifugal forces required for a wide variety of applications. Together with the compatible Beckman Coulter rotors, applications include:

- Routine processing such as sample preparations, pelleting, extractions, purifications, concentrations, phase separations, and spin column and spin filter centrifugations.

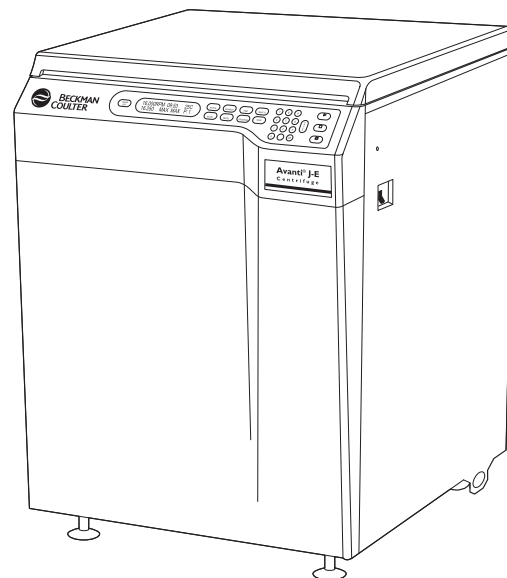

Figure 1-1. The Avanti® J-E Centrifuge

- Rapid sedimentation of protein precipitates, large particles, and cell debris.
- Preparation of subcellular organelles such as mitochondria, nuclei, chloroplasts, and crude microsomes.
- Separation of blood cells and cellular components.
- Gradient separation, for example, Ficoll-Hypaque¹ and Percoll.¹

The Avanti J-E is microprocessor-controlled, providing interactive operation. The instrument design features a brushless switched-reluctance drive motor,² a temperature control system with automatic temperature compensation unique for each compatible rotor, and selectable acceleration and deceleration rates.

Manual and programmed operation are available.

- In manual operation, you enter the individual run parameters before beginning each run.
- In programmed operation, you can duplicate runs quickly and accurately by selecting one of nine programs previously entered into the program memory.

User messages and/or audible signals are provided to alert you to conditions that may need attention.

HOUSING AND DOOR

The instrument housing is made of steel and molded structural foam. The door and structural-foam cover panels are finished with polyurethane enamel.

The steel and structural foam door is hinged at the back, providing clearance for loading and unloading of the centrifuge. In the event of a power failure, the door can be manually unlocked for sample recovery (see Section 4, TROUBLESHOOTING).

¹ Registered trademarks of Pharmacia AB.

² Manufactured under license from Switched Reluctance Drives Limited, Harrogate, U.K.

ROTOR CHAMBER

The rotor chamber is made of stainless steel to resist corrosion. A rubber gasket around the chamber opening ensures sealing. (Instrument gaskets have *not* been qualified as bioseals for aerosol containment.)

VACUUM

The friction reduction system (FRS) uses a mechanical rotary vane vacuum pump to reduce chamber pressure to approximately one-half atmosphere. The pump turns on when the run is started, before rotor friction reaches a high level. Vacuum in the chamber is vented automatically during rotor deceleration.

TEMPERATURE CONTROL

The temperature control system cools by circulation of a non-CFC-based refrigerant. The system is activated when the centrifuge power is on and when the door is closed and latched.

A thermistor in the rotor chamber continuously monitors the chamber temperature. The system calculates the chamber temperature required to maintain the set rotor temperature, $\pm 2^{\circ}\text{C}$. Although the chamber temperature fluctuates during operation, the rotor's large mass keeps the sample temperature substantially constant. At the end of a run, the system continues controlling the temperature for 30 minutes to prevent freezing or overheating of the sample.

NOTE

The system will always shut down using maximum brake if the temperature goes above 50°C .

DRIVE

The drive shaft is belt driven by a brushless, high-torque, switched-reluctance motor. The instrument's resilient suspension minimizes disturbance of the sample during acceleration and deceleration, and reduces damage to the drive shaft if an imbalance occurs during centrifugation.

CONTROLS AND INDICATORS

POWER SWITCH

The power switch, located on the right panel of the centrifuge, controls electrical power to the centrifuge. It is also a circuit breaker that will trip to cut off power in the event of a power overload. The power switch must be turned on before the chamber door can be opened.

CONTROL PANEL

The control panel (see Figure 1-2) is mounted at an angle on the centrifuge front for easy visibility and access. It is used to enter run parameters via function keys and a keypad, and to display run parameters, program information, and user messages.

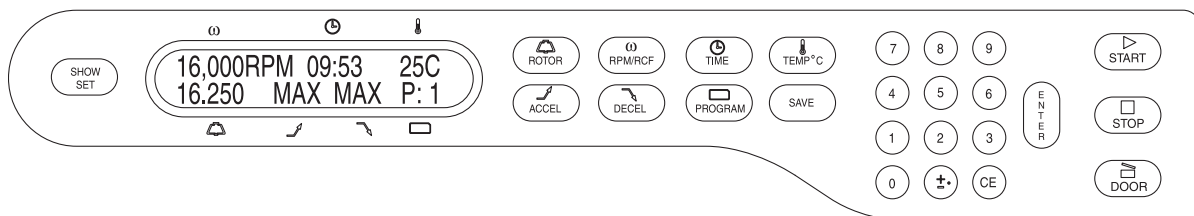

Figure 1-2. Control Panel

Digital Displays

The displays provide run information, user messages, and diagnostics.

- During a run, they show the actual (real-time) operating conditions.
- When the run parameters are being entered, they show the set values selected. Set values can be recalled during operation by pressing [**SHOW SET**]. After 5 seconds, the displays return to actual conditions.

(SPEED)

Indicates rotor speed in revolutions per minute (rpm) or in relative centrifugal field, a term describing the ratio of the centrifugal acceleration at a specified radius and speed to the standard acceleration of gravity ($\text{RCF} \times g$).

(TIME)

- In a timed run, indicates the remaining run time in hours and minutes. The time display begins counting down when [**START**] is pressed and continues counting down to 0, when deceleration begins. The run automatically ends when the set time reaches zero (a tone sounds when the rotor stops spinning). If a malfunction shuts down the centrifuge during a run, the time counting stops and the time remaining when the run stopped remains in the display. By comparing this time with the original set time, you can determine when the run ended.
- In a hold run, indicates the time elapsed since [**START**] was pressed. After 99 hours and 59 minutes the timer resets to 0 and continues counting elapsed time.

(TEMPERATURE)

Indicates rotor temperature in degrees C at thermoequilibrium. The displayed temperature is within ± 2 degrees of the set temperature (after equilibration).

(ROTOR)

Displays the name of the installed rotor.

(ACCEL)

When the [**ACCEL**] key is pressed, an acceleration rate (1 = MAX, 2 = SLOW) can be entered. If no number is entered, the instrument accelerates at the rate set for the previous run.

(DECEL)

When the [**DECEL**] key is pressed, a number representing the selected deceleration rate (1 = MAX, 2 = SLOW, 3 = OFF) can be entered. If no number is entered, the instrument decelerates at the rate set for the previous run.

 (PROGRAM)

- During setup—when the [**PROGRAM**] key is pressed a program number (one of nine possible) can be entered.
- During centrifugation—the number of the program being run is displayed.

Run-Parameter Keys

Run-parameter keys are used to enter specific run information as follows.



Pressed to display scrolling list of compatible rotors and rotor entry codes. Can be pressed repeatedly to scroll more quickly through the rotor list.

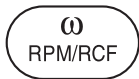

If the display shows speed in rpm, the key is pressed once to enter run speed (using the keypad) in rpm (revolutions per minute); pressed twice to enter run speed in RCF (relative centrifugal field). If the display shows speed in RCF, the key is pressed once to enter speed in RCF or twice to enter speed in rpm.



Pressed to enter run time using the keypad. When [**TIME**] is pressed twice, HOLD mode is selected. (Pressing it again reverts to time-entry mode.)

- Timed run—Run time up to 99 hours and 59 minutes can be set. If more than 59 minutes are entered in the minutes field, the system automatically converts the entry to hours and minutes. Deceleration begins when the set time counts down to zero.
- Continuous run (hold)—For runs of unspecified lengths, hold mode is used. When 99 hours, 59 minutes is reached, the system resets to 0 and continues counting. A hold run continues until the [**STOP**] key is pressed.

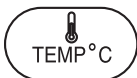

Pressed to enter run temperature (using the keypad), from -10 to +40°C. If a new temperature is not entered, the centrifuge uses the temperature set for the previous run.



The centrifuge has two acceleration profiles: MAX—maximum acceleration from 0 rpm to set speed, or SLOW—slow acceleration from 0 to 500 rpm, followed by maximum acceleration to set speed. The [ACCEL] key is used to select the maximum acceleration or slow acceleration, provided to maintain optimum separation.



The centrifuge has three deceleration profiles: MAX—full dynamic braking to 0 rpm; SLOW—brake to 500 rpm followed by reduced braking to a gentle stop; OFF (coast from set speed to stop). The [DECEL] key is used to select the deceleration rate provided to maintain optimum separation.



A toggle switch used to enter into and exit out of the program mode to create or recall programs. When the key is pressed, the program number can be selected using the keypad.



Saves the program in memory after program run parameters have been entered.

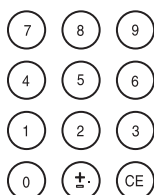

The keypad is used to enter numerical run parameters, to enter or recall a program number, and to select acceleration and/or deceleration rates. In addition to keys 0 through 9, the keypad includes plus or minus/decimal key and a [CE] (clear entry) key.

The [±.] key is used to enter a temperature setting below 0°C (for example, -2°C), or to enter a decimal point in a rotor entry code, depending on the parameter key selected.

The [CE] (clear entry) key clears any parameter on the display. Pressing [CE] will also clear some diagnostic messages. If a diagnostic message does not clear when [CE] is pressed, see Section 4, TROUBLESHOOTING.



The [ENTER] key can be pressed to save parameter inputs to system memory during manual run setup, and to start the centrifuge ([ENTER], then [START] must be pressed to start the centrifuge).



Pressed during a run to display set values for 5 seconds.



Pressing [**ENTER**], then [**START**] begins the run. ([**START**] must be pressed within 5 seconds of pressing [**ENTER**].) This key combination can also be used to abort a deceleration process and restart the centrifuge.



Can be pressed at any time while the rotor is spinning to terminate a run. The centrifuge decelerates to a complete stop according to the deceleration setting. The green light next to the key flashes while the rotor decelerates. An audio indicator sounds when the rotor comes to a complete stop.



Locks and unlocks the door. (The instrument will not accept the open command if the rotor is spinning.)

SAFETY FEATURES

The Avanti J-E centrifuge has been designed and tested to operate safely indoors at altitudes up to 2 000 m (6 562 ft). Safety features include the following.

DOOR

The steel and structural foam door has an electromechanical door-locking mechanism, with dual latches, to prevent operator contact with a spinning rotor. When the door is closed and [**DOOR**] is pressed, the latches automatically engage. (Door LED will come on.) It can be unlocked only by pressing [**DOOR**], and opened only when the power is on and the rotor is at rest. If there is a power failure, the door lock can be manually tripped for sample recovery (see Section 4, TROUBLESHOOTING).

PROTECTIVE RING

A structural steel ring surrounding the rotor chamber provides full operator protection.

IMBALANCE DETECTOR

An imbalance detector monitors the rotor during the run, causing automatic shutdown if rotor loads are severely out of balance. At low speeds, an incorrectly loaded rotor can cause an imbalance. Rotor instability can also occur if the instrument is moved, or if it is not resting level on the floor (see Section 4, TROUBLESHOOTING).

OVERSPEED AND ROTOR IDENTIFICATION SYSTEM

A rotor identification system prevents the installed rotor from running above its maximum rated speed. During acceleration the microprocessor checks the magnetic rotor identification. If the system identifies a rotor different than the one entered by the user, and the set speed is above the maximum for the identified rotor, the system will reduce the set speed to the maximum for the installed rotor.

A second check, based on rotor physical properties, is performed during acceleration. Speed is limited to the maximum safe speed of the identified rotor group.

NOTE

Some rotors manufactured before January, 2002, may not have magnets installed. Based on the rotor property grouping, these rotors may be limited to a lower speed than the rated speed.

NAME RATING PLATE

A name rating plate is affixed to the rear of the instrument. Always mention the serial number and model number when contacting Beckman Coulter regarding your Avanti J-E centrifuge.

SPECIFICATIONS

Only values with tolerances or limits are guaranteed data. Values without tolerances are informative data, without guarantee.

Speed

Set speed	300 to 21 000 rpm in 10-rpm increments
Speed control	actual rotor speed, ± 50 rpm of set speed
Speed display	actual rotor speed in 10-rpm increments or actual rcf $\times g$

Time

Set time	to 99 hours 59 minutes or continuous (hold)
----------	--

Time display

Timed run	indicates run time remaining
Hold run	displays elapsed time

Temperature

Set temperature	-10 to $+40^{\circ}\text{C}$ in 1° increments
Temperature control (after equilibration)	$\pm 2^{\circ}\text{C}$ of set temperature
Ambient temperature range	15 to 35°C

Humidity restrictions $<95\%$ (noncondensing)

Vacuum $1/2$ atmosphere

Acceleration two profiles—MAX (full acceleration to set speed)
and SLOW

Deceleration three profiles—MAX, SLOW, and OFF (coast)

Dimensions

Width	63.5 cm (25 in.)
Depth	80.0 cm (31.5 in.)
Height (door closed)	91.4 cm (36 in.)
Height (door open)	152.4 cm (60 in.)

Weight 267.4 kg (589 lb)

Ventilation clearances

Sides	7.6 cm (3.0 in.)
Rear	16.0 cm (6.25 in.)

Finishes

Control panel	silicone elastomer
Top surface	urethane paint
Other surfaces	acrylic baking enamel

Electrical requirements

208/240-V instrument	187–229/216–264 VAC, 24 A, 60 Hz
230-V instrument	207–253 VAC, 24 A, 50 Hz
200-V instrument	180–220 VAC, 24 A, 50 Hz

Electrical supply Class I

Maximum heat dissipation into room under

steady-state conditions 6 900 Btu/hr (2 kW)

Noise level 0.91 m (3 ft) in front of centrifuge at 21 000 rpm <64 dBa

Installation (overvoltage) category II

Pollution degree 2*

* Normally only nonconductive pollution occurs; occasionally, however, a temporary conductivity caused by condensation must be expected.

AVAILABLE ROTORS

Refer to the applicable rotor manual for complete rotor descriptions.

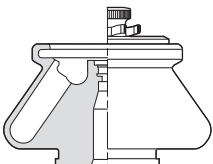
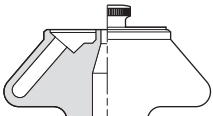
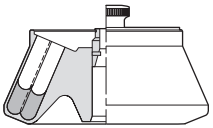
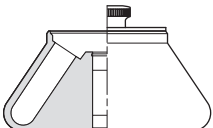
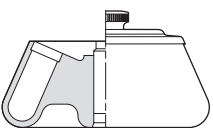
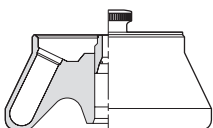
Rotor Profile and Description	Rotor Entry Code	Max RPM ^a	Max RCF (× g)	Max Capacity	Rotor Manual Number
JA-25.50 Fixed Angle, 34° (8 place)  $r_{\max} = 108 \text{ mm}$	25.5	21 000 ^b (18 000 @ 2°C) ^c	53 300	8 × 50 mL	J-TB-056
JA-21 Fixed Angle, 40° (18 place)  $r_{\max} = 102 \text{ mm}$	21	21 000 (18 000 @ 2°C) ^c	50 400	18 × 10 mL	J-TB-002
JA-20.1 Fixed Angle, 23° (32 place)  $r_{\max} = 115 \text{ mm}$ (outer row) $r_{\max} = 98 \text{ mm}$ (inner row)	20.1	20 000 (17 000 @ 2°C) ^c	51 500 43 900	32 × 15 mL	J-TB-022
JA-20 Fixed Angle, 34° (8 place)  $r_{\max} = 108 \text{ mm}$	20	20 000 (17 000 @ 2°C) ^c	48 400	8 × 50 mL	J-TB-003
JA-18 Fixed Angle, 23° (10 place)  $r_{\max} = 132 \text{ mm}$	18	16 000 ^d (14 000 @ 2°C) ^c	37 800	10 × 100 mL	J-TB-035
JA-17 Fixed Angle, 25° (6 place)  $r_{\max} = 132 \text{ mm}$	17	17 000 ^e (15 000 @ 2°C) ^c	39 800	14 × 50 mL	J-TB-017

^a Maximum speeds are based on a solution density of 1.2 g/mL in all rotors.

^b Maximum speed for the rotor in the Avanti® J-E centrifuge.

^c At 35°C ambient temperature and 95 percent humidity.

^d Maximum speed in the Avanti J-E for the rotor with magnets; without magnets maximum is 14 000 rpm. (Maximum speed at 2°C in a 50-Hz centrifuge is 14 000 rpm.)

^e Maximum speed for rotor without magnets is 13 000 rpm.

^f Temperature performance for the F14BCI-14x50cy rotor in the Avanti J-E is as follows: 12°C minimum at 14 000 rpm (at 35°C ambient); 4°C minimum at 13 000 rpm (35°C ambient).

^g Maximum speed for rotor without magnets is 6 300 rpm.

Description

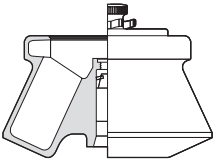
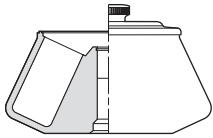
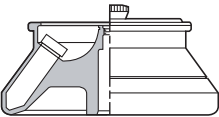
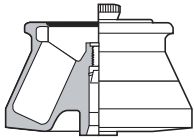
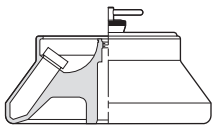
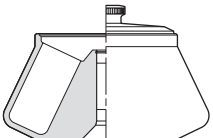
Rotor Profile and Description	Rotor Entry Code	Max RPM ^a	Max RCF (× g)	Max Capacity	Rotor Manual Number
<p>JLA-16.250 Fixed Angle, 25° (6 place)</p>  <p>$r_{\max} = 134 \text{ mm}$</p>	16.25	16 000 ^d (14 000 @ 2°C) ^c	38 400	6 × 250 mL	J-TB-072
<p>JA-14 Fixed Angle, 25° (6 place)</p>  <p>$r_{\max} = 137 \text{ mm}$</p>	14	14 000	30 100	6 × 250 mL	J-TB-004
<p>F14BCI-14x50cy Fixed Angle, 34° (14 place)^f</p>  <p>$r_{\max} = 153 \text{ mm}$</p>	50	14 000	33 500	14 × 50 mL	—
<p>F14BCI-6x250y Fixed Angle, 23° (6 place)</p>  <p>$r_{\max} = 137 \text{ mm}$</p>	250	14 000	30 000	6 × 250 mL	—
<p>JA-12 Fixed Angle, 35° (12 place)</p>  <p>$r_{\max} = 144 \text{ mm}$</p>	12	12 000	23 200	12 × 50 mL	J-TB-051
<p>JA-10 Fixed Angle, 25° (6 place)</p>  <p>$r_{\max} = 158 \text{ mm}$</p>	10	10 000 ^g	17 700	6 × 500 mL	J-TB-006

^a Maximum speeds are based on a solution density of 1.2 g/mL in all rotors.

^b Maximum speed for the rotor in the Avanti® J-E centrifuge.

^c At 35°C ambient temperature and 95 percent humidity.

^d Maximum speed in the Avanti J-E for the rotor with magnets; without magnets maximum is 14 000 rpm. (Maximum speed at 2°C in a 50-Hz centrifuge is 14 000 rpm.)

^e Maximum speed for rotor without magnets is 13 000 rpm.

^f Temperature performance for the F14BCI-14x50cy rotor in the Avanti J-E is as follows: 12°C minimum at 14 000 rpm (at 35°C ambient); 4°C minimum at 13 000 rpm (35°C ambient).

^g Maximum speed for rotor without magnets is 6 300 rpm.

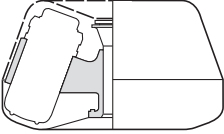
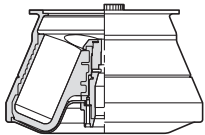
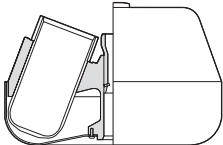
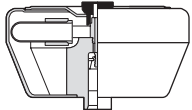
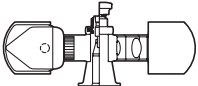
Rotor Profile and Description	Rotor Entry Code	Max RPM ^a	Max RCF ($\times g$)	Max Capacity	Rotor Manual Number
JLA-10.500 Fixed Angle, 20° (6 place)  $r_{\max} = 166 \text{ mm}$	10.5	10 000 ^g	18 600	6 \times 500 mL	J-TB-048
F10BCI-6x500y Fixed Angle, 23° (6 place)  $r_{\max} = 158 \text{ mm}$	500	10 000	17 696	6 \times 500 mL	—
JLA-9.1000 Fixed Angle, 20° (4 place)  $r_{\max} = 185 \text{ mm}$	9.1	6 300 ^b	8 230	4 \times 1000 mL	J-TB-073
JS-13.1 Swinging Bucket (6 place)  $r_{\max} = 140 \text{ mm}$	13	13 000 (12 000 @ 2°C) ^c	26 500	6 \times 50 mL	J-TB-036
JS-5.3 Swinging Bucket (4 place)  $r_{\max} = 194.8 \text{ mm}$	5.3	5 300	6 130	4 \times 500 mL 24 microplates 8 deep-well plates 4 square-well plates	J-TB-089

^a Maximum speeds are based on a solution density of 1.2 g/mL in all rotors.

^b Maximum speed for the rotor in the Avanti® J-E centrifuge.

^c At 35°C ambient temperature and 95 percent humidity.

^d Maximum speed in the Avanti J-E for the rotor with magnets; without magnets maximum is 14 000 rpm. (Maximum speed at 2°C in a 50-Hz centrifuge is 14 000 rpm.)

^e Maximum speed for rotor without magnets is 13 000 rpm.

^f Temperature performance for the F14BCI-14x50cy rotor in the Avanti J-E is as follows: 12°C minimum at 14 000 rpm (at 35°C ambient); 4°C minimum at 13 000 rpm (35°C ambient).

^g Maximum speed for rotor without magnets is 6 300 rpm.

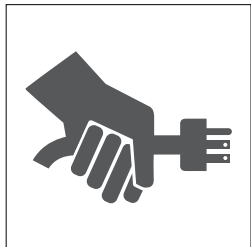

Preinstallation Requirements

Preinstallation requirements have been provided for your Avanti[®] J-E centrifuge. The following information is included in case the instrument must be relocated. (After the centrifuge is moved it must be leveled by adjusting the two front feet.)

NOTE

This centrifuge is designed to be installed by a Beckman Coulter Field Service representative. Installation by anyone other than authorized Beckman Coulter personnel invalidates any warranty covering the instrument.

SPACE REQUIREMENTS



WARNING

Do not place the centrifuge near areas containing flammable reagents or combustible fluids. Vapors from these materials could enter the centrifuge air system and be ignited by the motor. Maintain a 30-cm (1-ft) clearance area around the centrifuge while it is running. No persons or any hazardous materials should be within this area while the centrifuge is operating except to change operating controls, if required.

If it is necessary to move the centrifuge, maintain the following conditions.

- Select a location away from heat-producing laboratory equipment, with sufficient ventilation to allow for heat dissipation.
- The centrifuge must have adequate air ventilation to ensure compliance to local requirements for vapors produced during centrifuge operation.
- Position the centrifuge on a level floor that can support the weight of the centrifuge and resist vibration.
- In addition to space for the instrument itself, allow a 7.7-cm (3-in.) clearance on each side of the instrument and a 16-cm (6.25-in.) clearance behind the instrument for air circulation. The centrifuge must have adequate air ventilation to ensure compliance to local requirements for vapors produced during operation.

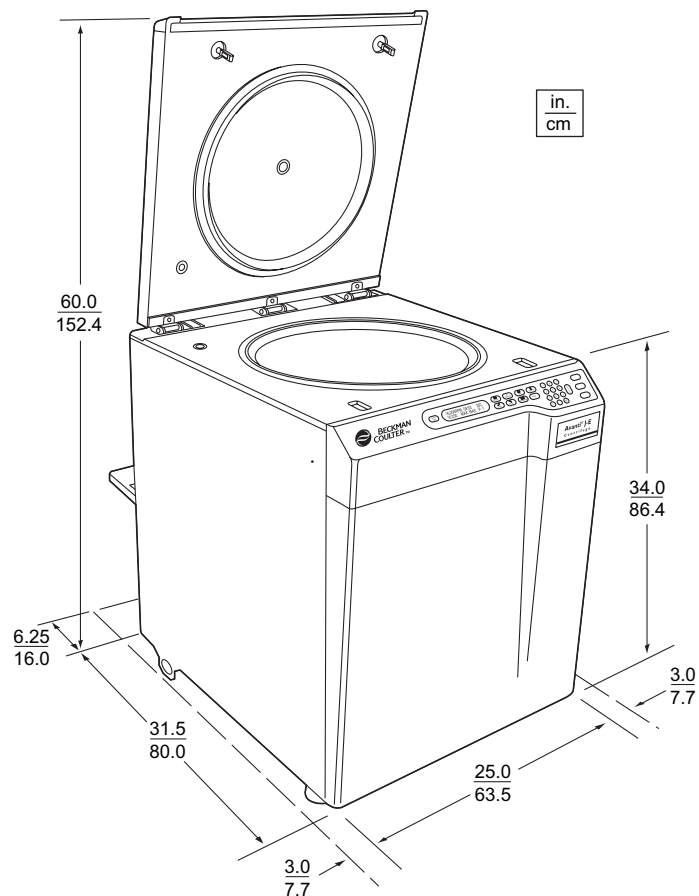

Figure 2-1. Dimensions of the Avanti® J-E Centrifuge

- Position the centrifuge so that the air diverter nearly touches the wall behind the centrifuge. Place the power cord to one side of the air diverter. To avoid damaging the power cord when installing or moving the centrifuge, be sure to move the cord out of the way before pushing the centrifuge toward the wall.
- Relative humidity should not exceed 95% (noncondensing).

ELECTRICAL REQUIREMENTS

200-V centrifuge	180–220 VAC, 24 A, 50/60 Hz
230-V centrifuge	207–253 VAC, 24A, 50/60 Hz
208/240-V centrifuge.	187–229/216–264 VAC, 24A, 50 Hz

To reduce the risk of electrical shock, this centrifuge uses a permanently attached 1.8-m (6-ft) three-wire UL/CSA approved electrical cord and plug to connect the centrifuge to earth-ground. (Contact your local Beckman Coulter office for specific information regarding local plug requirements.) To preserve this safety feature:

- Power to the centrifuge should originate directly from a main power line transformer at a power source known to be clear of erratic loads, spikes, and electromagnetic interference. Make sure there are properly rated thermal circuit breakers at the wall service panel to protect the centrifuge circuit. If fuses must be used instead of the specified circuit breakers, the fuses may require a rating of greater than 30 amperes. Figure 2-2 shows the power connection.

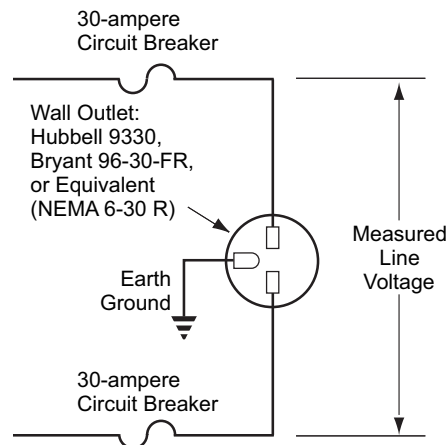

Figure 2-2. Single-Phase Power Connection



WARNING

To reduce the risk of electrical shock, this equipment uses a three-wire or five-wire electrical cord and plug to connect the centrifuge to earth-ground. To preserve this safety feature, make sure that the matching wall outlet receptacle is properly wired and earth-grounded. Check that the line voltage agrees with the voltage listed on the name rating plate affixed to the centrifuge.

- Never use a three-to-two wire plug adapter.
- Never use a two-wire extension cord or a two-wire non-grounding type of multiple-outlet receptacle strip.
- If there is any question about voltage, have a qualified service person measure it under load while the drive is operating.

To ensure safety the centrifuge should be wired to a remote emergency switch in order to disconnect the centrifuge from the main power source in case of a malfunction.

SECURING THE CENTRIFUGE TO THE FLOOR

Avanti J series centrifuges are certified to meet the requirements of the European CE mark. To meet these requirements, the centrifuge must be secured to the floor using the anchoring hardware shipped with the instrument. This will prevent the centrifuge from moving in the unlikely event of a rotor mishap.

Complete instructions for installing the anchoring kit are packaged with the hardware, which is shipped with the centrifuge. The instructions (publication SJ-TB-003) include a full-size template to be used as a guide for drilling holes in the floor. Refer to this document for additional installation instructions.

NOTE

Beckman Coulter representatives are not equipped to drill holes in your floor. The holes must be drilled before your scheduled installation.

BIO-SAFETY LEVEL 3 INSTALLATION

For laboratories with epoxy aggregate floors, such as BSL-3 labs, a non-invasive installation kit (PN 393830) is available. The kit which consists of an adhesive-backed mounting plate, is CSA certified for use on epoxy aggregate floors only.

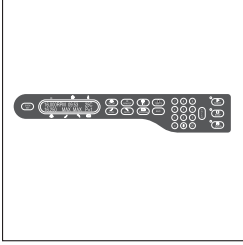

This section contains manual and programmed operating procedures. A summary is provided at the start of this section. If you are an experienced user of this centrifuge, you can turn to the summary for a quick review of operating steps.



WARNING

Normal operation may involve the use of solutions and test samples that are pathogenic, toxic, or radioactive. Handle body fluids with care because they can transmit disease. No known test offers complete assurance that they are free of micro-organisms. Some of the most virulent—Hepatitis (B and C) and HIV (I–V) viruses, atypical mycobacteria, and certain systemic fungi—further emphasize the need for aerosol protection. Handle other infectious samples according to good laboratory procedures and methods to prevent spread of disease. Because spills may generate aerosols, observe proper safety precautions for aerosol containment. Do not run toxic, pathogenic, or radioactive materials in this centrifuge without taking appropriate safety precautions. Biosafe containment should be used when Risk Group II materials (as identified in the World Health Organization *Laboratory Biosafety Manual*) are handled; materials of a higher group require more than one level of protection.

**WARNING**

Do not use the centrifuge in the vicinity of flammable liquids or vapors, and do not run such materials in the instrument. Do not lean on the instrument or place items on it while it is operating.

SUMMARY OF RUN PROCEDURES

For runs at other than room temperature, refrigerate or warm the rotor beforehand for fast equilibration.

PROGRAMMED RUN

1	POWER	Turn the power switch on (I).
2	[DOOR]	Press [DOOR] to unlock the chamber door; lift the door open.
3		Install the rotor according to the applicable rotor manual, then close the chamber door and press [DOOR].
4	[PROGRAM]	Press [PROGRAM], use the keypad to enter the required program number, then press [ENTER]. Press [SHOW SET] to display program parameters.
5	[ENTER] [START]	Check that all parameters are correct and that the door is closed. Press [ENTER], then press [START] (within 5 seconds).
6	[STOP]	Wait for the run to end, or end the run by pressing [STOP].
7	[DOOR]	When the rotor stops (a tone sounds), press [DOOR] to unlock the chamber door; lift the door open to remove the rotor.

MANUAL RUN

1	POWER	Turn the power switch on (I).
2	[DOOR]	Press [DOOR] to unlock the chamber door; lift the door open.
3		Install the rotor according to the applicable rotor manual, then close the chamber door and press [DOOR].
4	[ROTOR]	Press [ROTOR], then use the keypad to enter the rotor entry code.
5	[RPM/RCF]	Press [RPM/RCF], then use the keypad to enter the run speed (300 to 21 000 rpm). Press [RPM/RCF] a second time to enter speed in RCF.
6	[TIME]	Press [TIME], then use the keypad to enter the run time (to 99 hrs, 59 minutes); or press [TIME] twice for a hold (continuous) run.
7	[TEMP °C]	Press [TEMP °C], then use the keypad to enter the required run temperature (–10 to +40°C).
8	[ACCEL]	Press [ACCEL], then use the keypad to enter the selected acceleration rate number, 1 or 2.
9	[DECEL]	Press [DECEL], then use the keypad to enter the selected deceleration rate number, 1, 2, or 3.
10	[ENTER] [START]	Check that all parameters are correct and that the door is closed. Press [ENTER], then press [START] (within 5 seconds).
11	[STOP]	Wait for the set time to count down to zero, or end the run by pressing [STOP].
12	[DOOR]	When the rotor stops (a tone sounds), press [DOOR] to unlock the chamber door; lift the door open to remove the rotor or sample.

PREPARATION

Prepare the rotor for centrifugation as described in the applicable rotor manual. *For runs at other than room temperature, refrigerate or warm the rotor beforehand for fast equilibration.*

INSTALLING THE ROTOR

The power must be turned on before you can unlock and open the chamber door. (To end a run for any reason, do not turn the power switch off; press [**STOP**] instead.)

Action

1. Turn the power switch on.
2. Press [**DOOR**] to unlock the door.
3. Lift the door up to open.

Result

Indicator lights on the control panel light up.

The instrument will accept this command only when the rotor is at rest.

4. Install the rotor according to directions in the rotor manual. Ensure that the rotor is seated on the drive hub. Avoid bumping the control panel keys during rotor installation or removal. (If you bump the control panel and an L1 diagnostic appears, press [**CE**] to clear the message.)



CAUTION

Rotors used in Avanti J series centrifuges must have drive pins in the rotor drive hole. These drive pins engage with the centrifuge drive hub to ensure that the rotor does not slip during acceleration. Some Beckman Coulter rotors were originally manufactured without drive pins because these rotors did not need pins to run in older model centrifuges. To check for drive pins, hold the rotor up or turn it on its side and look into the drive hole. If you do not see at least two metal pins near the top of the hole, do not use the rotor in the Avanti J-E.

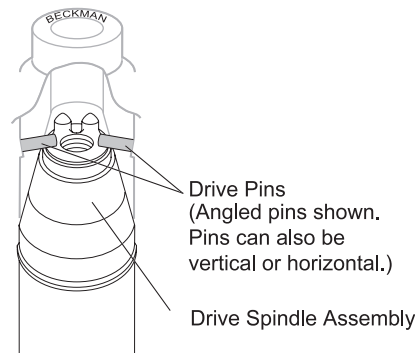

Action

-
5. Close the chamber door and press [**DOOR**]. (To keep the chamber clean and dry, leave the door closed whenever possible.)

Result

The door latches. When the latches engage, the LED next to the [**DOOR**] key lights.

MANUAL OPERATION

- When a run-parameter key ([**ROTOR**], [**RPM/RCF**], [**TIME**], [**TEMP**], [**ACCEL**], or [**DECEL**]) is pressed, a parameter can be entered or changed. Entry is completed when [**ENTER**] or another function key is pressed.
- To change an entry before you've pressed [**ENTER**] or another parameter key, press [**CE**] and enter a different value. To change an entry after you've pressed [**ENTER**], press the run-parameter key again.
- If an unacceptable value is entered, the valid range for that parameter is displayed in the message line. Enter the correct value.

SELECTING A ROTOR**Action**

-
1. Press [**ROTOR**].
 2. Use the keypad to select a rotor by entry code number.
 3. Press the next run-parameter key or press [**ENTER**].

Result

A list of rotors, with rotor entry codes, scrolls across the display.

NOTE

An alternate method of selecting a rotor is to press [**ROTOR**] repeatedly; the rotor number changes each time the key is pressed. When the rotor you are using is displayed, press [**ENTER**].

ENTERING RUN SPEED

Enter a run speed up to the maximum speed of the rotor in use (21 000 rpm maximum). Or, enter a relative centrifugal field (RCF) value up to the maximum achievable RCF of the rotor.

Action

Result

- | | |
|---|--|
| 1. Press [RPM/RCF] once to enter speed in RPM or twice to enter speed in RCF. | Allowed speed for the selected rotor is displayed. |
| 2. Use the keypad to enter required speed. | Entered speed appears on the speed display. (If the entered speed is higher than the rated speed of the installed rotor, a message showing the valid speed range will be displayed. Press [CE] and enter an acceptable value.) |
| 3. Press the next run-parameter key or [ENTER]. | You can change the set speed at any time by repeating steps 1 through 3. The rotor will accelerate or decelerate to the new speed. |

NOTE

During acceleration, the instrument identifies the rotor and checks its maximum allowable speed. If set speed is greater than the rotor group's maximum allowable speed, the rotor will decelerate to its rated speed, and an error message will be displayed. Refer to Section 4, TROUBLESHOOTING.

ENTERING RUN TIME

Run time can be set for up to 99 hours and 59 minutes or for a hold (continuous) run. The time display begins counting down when the rotor starts to spin. For a timed run, the run automatically terminates when the set time reaches zero; a tone sounds when the rotor has stopped. For a hold run, the elapsed time is displayed and the run continues until [STOP] is pressed.

<i>Action</i>	<i>Result</i>
1. Press [TIME].	The cursor appears.
2. Use the keypad to enter required time.	Entered time appears on the display. If you entered a number higher than 59 minutes, the centrifuge automatically recalculates the time in hours and minutes.
or	
Press [TIME] again for a hold run.	HOLD appears on the display.
3. Press the next run-parameter key or [ENTER].	

ENTERING RUN TEMPERATURE

Run temperature can be set from -10 to $+40^{\circ}\text{C}$. If no value is entered, the centrifuge selects the last entered temperature.

<i>Action</i>	<i>Result</i>
1. Press [TEMP].	The cursor and the temperature range for the selected rotor appear.
2. Use the keypad to enter required temperature.	Entered temperature appears on the display. (If the entered temperature is lower than can be achieved for the installed rotor, a message showing “Input error temp” will be displayed.)
3. Press the next run-parameter key or [ENTER].	

ENTERING ACCELERATION AND DECELERATION RATES

The instrument provides a choice of two acceleration rates and three deceleration rates to protect the gradient and sample-to-gradient interface. The acceleration time is the time it takes a rotor to reach set speed from rest. The deceleration time is the time it takes a rotor to decelerate from set speed to rest.

Action

Result

- | | |
|---|---|
| 1. Press [ACCEL]. | Acceleration options are displayed. |
| 2. Press the keypad number for the required acceleration rate—1 = MAX, 2 = SLOW. | Entered acceleration rate appears on the display. |
| 3. Press the next run-parameter key or [ENTER]. | |
| 4. Press [DECEL]. | Deceleration options are displayed. |
| 5. Press the keypad number for the required deceleration rate—1 = MAX; 2 = SLOW; 3 = OFF. | Entered deceleration rate appears on the display. |

STARTING A RUN

Action

1. Press [ENTER] and [START].

Result

The green light next to the [START] key flashes and the rotor begins to spin.

NOTE

To begin a run, [ENTER] must always be the last key pressed before pressing [START]. If you wait more than 5 seconds, the [START] key will not activate. If this happens, press [ENTER] and [START] again to begin the run.

If an unacceptable value was entered, the run will not begin when [ENTER] and [START] are pressed. Check the display and make any necessary corrections or additions. Press [ENTER] and [START] again to begin the run.

The run will end when the time display counts down to zero. (Press [STOP] to terminate a run for any reason.) The green light next to the [STOP] key will flash while the rotor decelerates. A tone sounds when the rotor comes to a complete stop.

2. After the rotor has stopped, press [DOOR].

The door is unlocked.

3. Remove the rotor. Keep the chamber door closed between runs.

PROGRAMMED OPERATION

The instrument internal memory can store up to nine programs which can be recalled by keypad numbers 1 through 9. Saved programs are retained in memory even if the power is turned off. Procedures for entering run parameters are the same for programmed operation as those described above for manual operation.

CREATING A NEW PROGRAM

<i>Action</i>	<i>Result</i>
1. Press [PROGRAM].	Previously saved program numbers are displayed.
2. Use the keypad to select a program number that is not in use or one that you want to overwrite and press [ENTER].	The message “Press [ENTER] [START] to run, or edit parameters” is displayed.
3. Enter run parameters (speed, time, temperature, acceleration/deceleration rate settings).	If you entered an unacceptable parameter, an error message will be displayed. (Press [CE] and enter an acceptable value, then press the next run-parameter key.)
4. When all parameters are entered, press [SAVE].	The program is saved into memory.

 **NOTE**

Record the program parameters on the Program Library record (233679).

5. Press [**ENTER**] [**START**] to run the programmed run (or press [**PROGRAM**] to exit program mode and return to manual operation).

STARTING A PROGRAMMED RUN

<i>Action</i>	<i>Result</i>
1. Press [PROGRAM].	Previously saved program numbers are displayed.
2. Use the keypad to enter the number of the program, then press [ENTER].	The message “Press [ENTER] [START] to run, or edit parameters” is displayed.

Action**Result**

3. Press [**SHOW SET**].

The number you selected will appear in the program display. Run parameters for that program will be displayed for 5 seconds. (To make changes, see Changing a Program, below.)

4. Press [**ENTER**] and [**START**] to begin the programmed run (or press [**PROGRAM**] to exit program mode and return to manual operation).

The run starts, the green light next to the [**START**] key flashes, and the rotor begins to spin.

 **NOTE**

To begin a run, [**ENTER**] must always be the last key pressed before pressing [**START**]. If you wait more than 5 seconds, the [**START**] key will not activate. If this happens, press [**ENTER**] and [**START**] again to begin the run.

If an unacceptable value was entered, the run will not begin when [**ENTER**] and [**START**] are pressed. Check each display and make any necessary corrections or additions. Press [**ENTER**] and [**START**] again to begin the run.

The run will end automatically when the time display counts down to zero. (Press [**STOP**] to terminate a run at any time.) The green light next to the [**STOP**] key will flash while the rotor decelerates. A tone will sound when the rotor has come to a complete stop.

5. After the rotor has stopped, press [**DOOR**].

The door is unlocked.

6. Remove the rotor. Keep the chamber door closed between runs.

RECALLING AND CHANGING A PROGRAM

Recalling a Program

A program that has been saved in memory can be recalled at any time.

Action

Result

- | | |
|---|--|
| 1. Press [PROGRAM]. | Previously saved program numbers in use are displayed. |
| 2. Select the appropriate keypad number and press [ENTER]. | The message “Press [ENTER] [START] to run, or edit parameters” is displayed. |
| 3. Press [SHOW SET] to display program parameters. | |
| 4. To begin the run, press [ENTER] and [START]. | The run starts. |

Changing a Program

Action

Result

- | | |
|---|---|
| 1. Press [PROGRAM]. | Previously saved program numbers are displayed. |
| 2. Select the appropriate keypad number and press [ENTER]. | The message “Press [ENTER] [START] to run, or edit parameters” is displayed. |
| 3. Press [SHOW SET] to display program parameters. | |
| 4. Press the run parameter key to be changed. | Parameter prompts are displayed. |
| 5. Use the keypad to enter the new value. | |
| 6. Repeat steps 4 and 5 to change other run parameters. When all changes have been entered, press [SAVE]. | The revised program will remain in memory until further changes are made and saved. Record the changes on your Program Library record (233679). |
| 7. Press [ENTER] and [START] to begin the programmed run (or press [PROGRAM] to exit program mode and return to manual operation). | The run starts. |



Troubleshooting

This section lists possible malfunctions, together with probable causes and corrective actions. Maintenance procedures are given in Section 5. For any problems not covered here, contact Beckman Coulter Field Service (1-800-742-2345 in the United States; worldwide offices are listed on the back cover of this manual) for assistance.

NOTE

It is your responsibility to decontaminate the instrument, as well as any rotors and/or accessories, before requesting service by Beckman Coulter Field Service.

USER MESSAGES

User messages appear on the display to communicate information about the instrument or to alert you to abnormal conditions that need attention.

- Help and informational messages caused by incorrect input or certain operating conditions can be cleared by pressing [CE] and following the instructions in the message.
- Diagnostic messages that result from abnormal operating conditions or equipment malfunction require troubleshooting. Refer to Table 4-1 to determine the nature of the condition and any recommended actions. If a problem persists after you have performed the recommended action, call Beckman Coulter Field Service. To help

the field service representative diagnose and correct the problem, try to gather as much inform about the situation as you can, including:

- the diagnostic number and message,
- the operating situation when the diagnostic condition occurred (such as rotor in use, speed, or load type), and
- any unusual environmental and/or operating conditions (such as ambient temperature or voltage fluctuations).

Table 4-1. Diagnostic Message Chart

Diagnostic Number/ Message	Problem	Result	Recommended Action
P1– Power failure occurred, see manual	Momentary power failure: rotor does not come to a complete stop	Run continues when power resumes	Press [CE] to clear message.
P2– Power failure, see manual	Power failure: rotor speed drops to <500 rpm	Run restarts automatically when power resumes	Press [CE] to clear message.
L1, L2, L5, L6, L11, and L12– Reclose door	Latches are not operating properly	Error message appears; run shuts down with maximum brake	Press down on the door and press [DOOR]. If you close the door repeatedly and the problem continues, gently clean the latch area with a lintless swab. Be careful not to damage sensitive electronics in the area. WARNING: Do not put your fingers into the latch openings. Press [CE] to clear message.
C1– Rotor temp exceeds 4C above set	Rotor temperature exceeds temperature setting by more than 4°C but less than 8°C	Run continues	Press [CE] to clear message.
C2– Rotor temp exceeds 8C above set	Rotor temperature exceeds temperature setting by more than 8°C	Run shuts down with maximum brake	Call Beckman Coulter service.
C3– Temp, call service	Cannot maintain temperature	Run shuts down with maximum brake	<ul style="list-style-type: none"> • Check the air filter and replace if dirty (see Section 5, MAINTENANCE). • Call Beckman Coulter service.

Continued—

Table 4-1. Diagnostic Message Chart (continued)

Diagnostic Number/ Message	Problem	Result	Recommended Action
C5– Temp, call service	Refrigeration system error	Run shuts down with maximum brake	Call Beckman Coulter service.
T1 through T4– Temp, call service	System temperature problem	Run shuts down with maximum brake	Call Beckman Coulter service.
D1 through D12, D14, and D15– Drive, call service	Drive system problem	Run stops, usually with no brake. Door may not unlock for up to an hour.	Call Beckman Coulter service. Before trying to open the door, listen carefully and make sure that no sound is coming from the chamber (indicating a spinning rotor). Follow the directions under ACCESSING THE ROTOR IN CASE OF POWER FAILURE, below.
D13– No rotor in chamber or drive problem	There is no rotor installed or the drive belt is loose or broken	Run shuts down with maximum brake.	<ul style="list-style-type: none"> • Install rotor per the applicable rotor manual. • If the rotor is installed when the message appears, call Beckman Coulter service.
F1 and F2– FRS,* call service	Required vacuum level not reached in allowed time	Run shuts down with maximum brake	<ul style="list-style-type: none"> • Check and clean door sealing area and door gasket. • Wipe any ice and excess moisture from chamber. • Call Beckman Coulter service.
R1, and R2– Rotor, ID problem	No magnets identified, or magnets incorrectly identified	Run continues, speed may be derated	Press [CE] to clear message. If problem repeats, check rotor magnets or call Beckman Coulter service.
R3, R4, and R8– Rotor, speed derated	The entered rotor number is not the same as the rotor identified	If identified rotor speed maximum is lower than entered maximum, the speed will be reduced to the rated maximum of the installed rotor	Press [CE] to clear message. Enter the correct rotor entry code.
R5 and R6– No rotor match	The system cannot identify the rotor	Run shuts down with maximum brake	<ul style="list-style-type: none"> • Make sure the rotor in use is a compatible Beckman Coulter rotor (see AVAILABLE ROTORS in Section 1). • Call Beckman Coulter service.
R9– Calibration error	Rotor calibration error	Run shuts down with maximum brake	<ul style="list-style-type: none"> • Make sure the rotor in use is a compatible Beckman Coulter rotor (see AVAILABLE ROTORS in Section 1). • Call Beckman Coulter service.

* Friction Reduction System.

Continued—

Table 4-1. Diagnostic Message Chart (continued)

Diagnostic Number/ Message	Problem	Result	Recommended Action
S1 through S14— System error, call service	There is a problem with the system control soft- ware, EPROM, or RAM	System shuts down	Call Beckman Coulter service.
H1, H5, H7, and H8— Speed, call service	Speed control problem	Run shuts down with maximum brake; door may not unlock for up to an hour.	Call Beckman Coulter service.
H2, H3, and H11— Speed, call service	Speed control problem	Run stops, usually with no brake	Call Beckman Coulter service.
H4, H6, and H9— Speed error	Accel or decel speed problem	Run continues	Press [CE] to clear message.
I1— Rotor imbalance	Rotor load is severely out of balance	Run shuts down with maximum brake	<ul style="list-style-type: none"> • Make sure that tubes or bottles are loaded symmetrically in the rotor. • With swinging bucket rotors, remove the buckets and lubricate the pivot pins where the buckets contact as described in the applicable rotor manual. Unlubricated pivot pins can prevent the buckets from reaching horizontal position, which can cause imbalance.
—	During low-tempera- ture runs (near -10°C), ice forms around the door opening	Door will not open at the end of a run	To minimize icing, wipe moisture from the chamber, the chamber gasket and the inner door surface before each run. Keep the door closed as much as possible.

RETRIEVING YOUR SAMPLE IN CASE OF POWER FAILURE

If facility power fails only momentarily, the instrument will resume operation when power is restored and the rotor will return to set speed. However, if the rotor came to a complete stop, you will have to restart the run when the power is restored. In either case, a power outage message will be displayed on the control panel to indicate that a power outage has occurred.



WARNING

Any maintenance procedure requiring removal of a panel exposes the operator to the possibility of electrical shock and/or mechanical injury. Therefore, turn the power off and disconnect the instrument from the main power source, and refer such maintenance to service personnel.

In the event of an extended power failure, it may be necessary to override the door-locking mechanism manually to remove the rotor and retrieve your sample.



WARNING

The following procedure should be implemented only when absolutely necessary and only by qualified service personnel.

Action

1. Turn the power off and disconnect the power cord from the main power source.

Result

No lights on the control panel are lit.



CAUTION

LISTEN CAREFULLY. Do not proceed if any sound or vibration is coming from the drive.

2. Insert the hex wrench (729317) or a similar tool into the openings on each side of the centrifuge (see Figure 4-1) to release the top front panel.

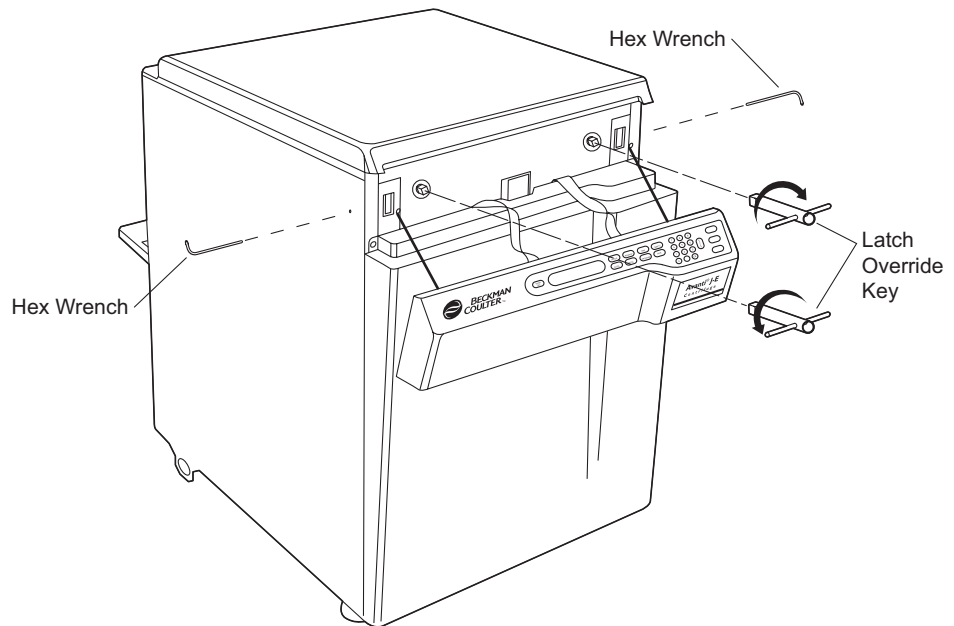

Figure 4-1. Manual Door Release

Action

3. Lower the panel as far as the tether cords allow.
4. Use the latch override key (368247) to turn the right-hand latch bolt to the right (clockwise) and the left-hand latch bolt to the left (counter-clockwise) until the latches release.
5. After removing the rotor, replace the top front panel by pushing it into place.

Result



CAUTION

Do not attempt to remove tether cords. They are required to assure safe operation of the centrifuge.



WARNING

NEVER try to slow or stop the rotor by hand.

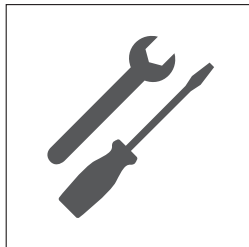

This section contains care and maintenance procedures that should be performed regularly. For maintenance not covered in this manual, contact Beckman Coulter Field Service (1-800-742-2345 in the United States) for assistance. User messages and recommended actions are discussed in Section 4, TROUBLESHOOTING. Refer to the applicable rotor manual and Rotors and Tubes for J Series Centrifuges (publication JR-IM) for instructions on the care of rotors and their accessories.

INSTRUMENT CARE

NOTE

It is your responsibility to decontaminate the instrument, as well as any rotors and/or accessories, before requesting service by Beckman Coulter Field Service.



WARNING

Any maintenance procedure requiring removal of a panel exposes the operator to the possibility of electrical shock and/or mechanical injury. Therefore, turn the power off and disconnect the instrument from the main power source, and refer such maintenance to service personnel.

MAINTENANCE

Perform the following procedures regularly to ensure continued performance and long service life of the centrifuge.

- Inspect the centrifuge chamber for accumulations of sample, dust, or glass particles from broken sample tubes. Clean as required (see CLEANING, below).
- Check the air filter on the back panel for obstructions. Keep vents clear and clean.
- Wipe condensation out of the rotor chamber between runs with a sponge or clean cloth to prevent chamber icing.
- If chamber icing occurs, defrost the system and wipe moisture out of the chamber before use. To defrost the system, set the temperature to 30°C for 20 minutes. (These are suggested settings which may be adjusted as appropriate for your laboratory conditions.)

NOTE

Before using any cleaning or decontamination methods except those recommended by the manufacturer, users should check with the manufacturer that the proposed method will not damage the equipment.

CLEANING

Clean the centrifuge frequently. Always clean up spills when they occur to prevent corrosives or contaminants from drying on component surfaces.



- To prevent accumulations of sample, dust, and/or glass particles from broken sample tubes, keep the chamber clean and dry by frequent wiping with a cloth or paper towel. For thorough cleaning, wash the chamber using a mild detergent such as Beckman Solution 555™, diluted 10 to 1 with water. Rinse thoroughly and dry completely.
- Clean the centrifuge exterior surfaces by wiping with a cloth dampened with Solution 555, diluted 10 to 1 with water. Do not use acetone.

- Clean the drive hub regularly using Solution 555 (diluted 10 to 1 with water) and a soft brush. Rinse thoroughly and dry completely.

Tube Breakage

If a glass tube breaks, and all the glass is not contained in the bucket or rotor, be sure to thoroughly clean the chamber.



WARNING

Be careful when examining or cleaning the chamber and chamber gasket, as sharp glass fragments may be embedded in their surfaces.

- Examine the chamber gasket to make that no glass particles are retained in it. Carefully remove any glass particles that may remain.
- Carefully wipe away any glass particles that remain in the chamber.

DECONTAMINATION



If the centrifuge and/or accessories are contaminated with radioactive or pathogenic solutions, perform all appropriate safety and decontamination procedures. Refer to *Chemical Resistances* (publication IN-175) to be sure the decontamination method will not damage any part of the instrument.

STERILIZATION AND DISINFECTION

The centrifuge is finished with urethane paint. Ethanol (70%)* may be used on this surface. See *Chemical Resistances* for chemical compatibilities of centrifuge and accessory materials.

* Flammability hazard. Do not use in or near operating centrifuges.

While Beckman Coulter has tested ethanol (70%) and found that it does not damage the centrifuge, no guarantee of sterility or disinfection is expressed or implied. When sterilization or disinfection is a concern, consult your laboratory safety officer regarding proper methods to use.

REPLACING THE AIR FILTER

Check the air filter (Figure 5-1) regularly and replace it about once a year, or more often if it looks dirty. The air filter is not fastened to the centrifuge, so no tools are required for removal or installation.

1. To remove the air filter, grasp the top edge and lift the filter straight up.
2. Install a new filter by holding the top edge and inserting the bottom edge into the slot in the air deflector strip. Lower the filter until the bottom edge rests on the brackets.

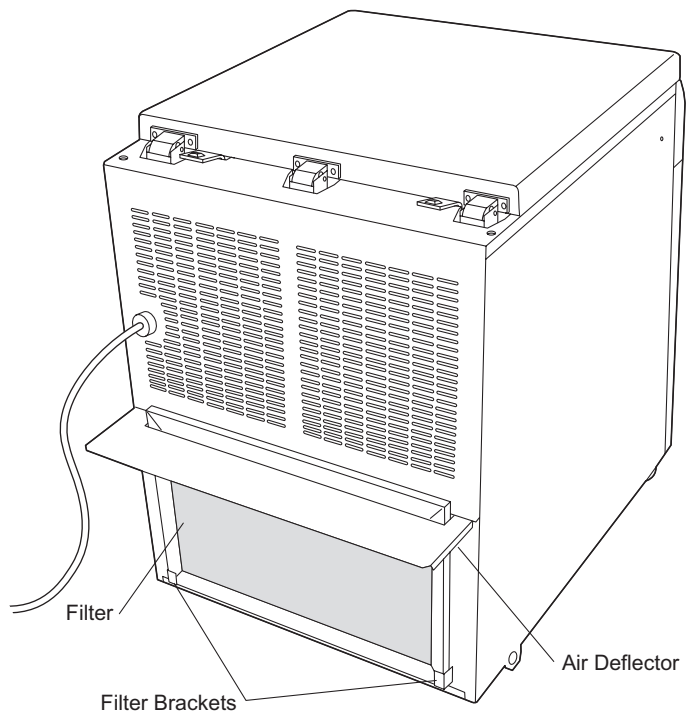

Figure 5-1. Air Filter Replacement

CIRCUIT BREAKER AND FUSES

There are no user-replaceable fuses in the centrifuge.

If the centrifuge circuit breaker trips for any reason, the power switch will move to the OFF (O) position. Reset the circuit breaker by turning the power switch back to the ON (I) position. If it trips again immediately, *do not reset it*. Call Beckman Coulter Field Service.



CAUTION

Repeated attempts to reset the centrifuge circuit breaker can cause substantial damage to electrical and electronic components.

STORAGE AND TRANSPORT

STORAGE

To ensure that the centrifuge does not get damaged, contact Beckman Coulter Field Service for specific instructions and/or assistance in preparing the equipment for transport or long-term storage. Temperature and humidity conditions for storage should meet the environmental requirements described under SPECIFICATIONS.

SUPPLY LIST

NOTE

Publications referenced in this manual can be obtained by calling Beckman Coulter at 1-800-742-2345 in the United States, or by contacting your local Beckman Coulter office.

Contact Beckman Coulter Sales (1-800-742-2345 in the United States; worldwide offices are listed on the back cover of this manual) for information about ordering parts and supplies. A partial list of supplies is given below for your convenience. See the Beckman Coulter *High Performance, High Speed, High Capacity Rotors, Tubes & Accessories* catalog (BR-8102, available at www.beckman-coulter.com) for detailed information on ordering rotors, tubes, and accessories.

REPLACEMENT PARTS

Air filter	978347
Latch override key	368247
Memory flash card kit	369173

SUPPLIES

Spinkote lubricant (2 oz)	306812
Silicone vacuum grease (1 oz)	335148
Beckman Solution 555 (1 qt)	339555
Hex key (panel removal)	729317
Program library record	233679

AVANTI® J-E CENTRIFUGE WARRANTY

Subject to the exceptions and upon the conditions specified below Beckman Coulter agrees to correct either by repair, or, at its election, by replacement, any defects of material or workmanship which develop within one (1) year (2 years for the drive motor) after delivery of the Avanti® J-E Centrifuge centrifuge (the product), to the original buyer by Beckman Coulter or by an authorized representative, provided that investigation and factory inspection by Beckman Coulter discloses that such defect developed under normal and proper use.

Some components and accessories by their nature are not intended to and will not function for as long as one (1) year. If any such component or accessory fails to give reasonable service for a reasonable period of time, Beckman Coulter will repair or, at its election, replace such component or accessory. What constitutes either reasonable service and a reasonable period of time shall be determined solely by Beckman Coulter.

REPLACEMENT

Any product claimed to be defective must, if requested by Beckman Coulter, be returned to the factory, transportation charges prepaid, and will be returned to Buyer with the transportation charges collect unless the product is found to be defective, in which case Beckman Coulter will pay all transportation charges.

Beckman Coulter makes no warranty concerning products or accessories not manufactured by it. In the event of failure of any such product or accessory, Beckman Coulter will give reasonable assistance to the Buyer in obtaining from the respective manufacturer whatever adjustment is reasonable in light of the manufacturer's own warranty.

CONDITIONS

Beckman Coulter shall be released from all obligations under all warranties, either expressed or implied, if the product covered hereby is repaired or modified by persons other than its own authorized service personnel, unless such repair by others is made with the written consent of Beckman Coulter, or unless such repair in the sole opinion of Beckman Coulter is minor, or unless such modifications is merely the installation of a new Beckman Coulter plug-in component for such product.

DISCLAIMER

IT IS EXPRESSLY AGREED THAT THE ABOVE WARRANTY SHALL BE IN LIEU OF ALL WARRANTIES OF FITNESS AND OF THE WARRANTY OF MERCHANTABILITY AND THAT BECKMAN COULTER, INC. SHALL HAVE NO LIABILITY FOR SPECIAL OR CONSEQUENTIAL DAMAGES OF ANY KIND WHATSOEVER ARISING OUT OF THE MANUFACTURE, USE, SALE, HANDLING, REPAIR, MAINTENANCE, OR REPLACEMENT OF THE PRODUCT.



Beckman Coulter, Inc. • 250 S. Kraemer Blvd. • Brea, California 92821
Sales and Service: 1-800-742-2345 • Internet: www.beckmancoulter.com

©2009 Beckman Coulter, Inc.
All rights reserved